

# Divert & Sterile Access Valves



Patent # 6,401,756

## Integral Sterile Access and GMP (ISG)

The ISG combines the functionality of the two most common process fabrications (Sterile Access (SA) and GMP) into one assembly, greatly reducing the deadlegs of conventional SA and GMP fabrications when a purge valve is required.

This is achieved by providing the purge valve integral to the main body design. By simply rotating the assembly, one fabricated block body can provide three process fabrication orientations: Standard Sterile Access Port (SA) and vertical GMP porting above and below the weir. The result is one integral valve assembly, which reduces contact surfaces and hold up volume, while minimizing dimensional envelope and increasing design flexibility.

## Typical Applications:

- Process diversion, steam barrier/block sampling

Integrated Block Valves

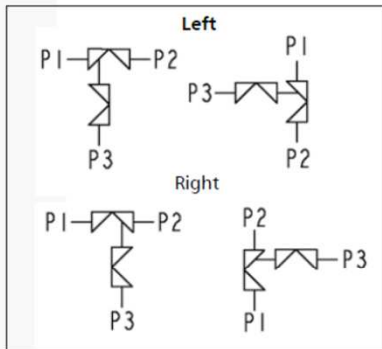

ISG

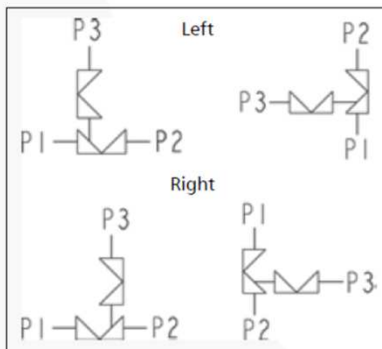

Inverted ISG

ISG Flow Path

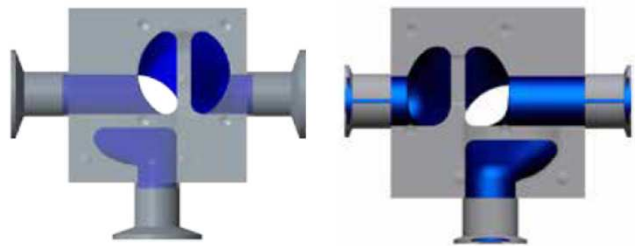

Inverted ISG Flow Path

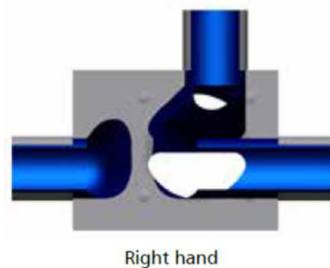

## VALVULAS Y PROCESOS 2007, S.L.

Orfeo Català, nr. 9  
Pol. Ind. Sud  
08440 - CARDEDEU  
S P A I N

TEL: 00 34 93 755 20 56  
FAX: 00 34 93 755 17 75  
e-mail: [jpicallo@vypl.es](mailto:jpicallo@vypl.es)  
VAT: ESB64719958

# Divert & Sterile Access Valves

## 2 through 6-Way Multiport Divert Valves

Divert valves are instrumental in achieving efficient, cost effective piping design. Divert valves allow process fluids to be diverted, mixed and/or sampled. ITT Pure-Flo is the first in the industry to incorporate the multiple weir block design. Divert valves minimize contact surfaces, minimize hold up volume, reduce CIP cycle times, improve product purity, minimize piping dimensional envelope, reduce number of system weldments, and are more easily actuated and validated then transfer panels.

### Typical Applications:

- Distribution of process flows (ie. mixing flow paths)
- 2-Way diverters are often used to switch between main and backup pumps on WFI loops
- Used in place of transfer panels
- Also used for bypass, drain and isolation
- CIP distribution
- Switching between buffers for Chromatography

Pure-Flo 2-Way Divert



Patent for 2-Way #  
6,237,637 and #  
5,427,150

EnviZion 2-Way Divert



Pure-Flo 5-Way Divert



Integrated  
Block Valves

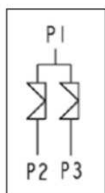

DV2W

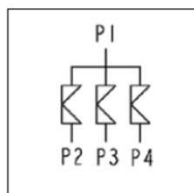

DV3W

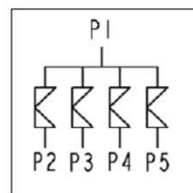

DV4W

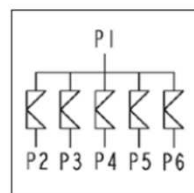

DV5W

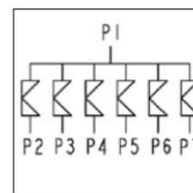

DV6W

### Flow Path

2-Way (DV2W)



3-Way (DV3W)

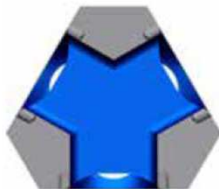

4-Way (DV4W)



5-Way (DV5W)



6-Way (DV6W)



## VALVULAS Y PROCESOS 2007, S.L.

Orfeó Català, nr. 9

Pol. Ind. Sud

08440 - CARDEDEU

SPAIN

TEL: 00 34 93 755 20 56

FAX: 00 34 93 755 17 75

e-mail: [jpicallo@vypl.es](mailto:jpicallo@vypl.es)

VAT: ESB64719958

# Divert & Sterile Access Valves

## Divert Outlet Options

Integrated Block Valves

2-Way

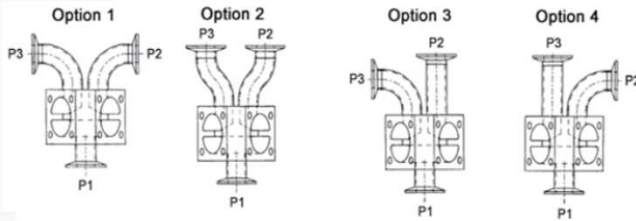

3-Way

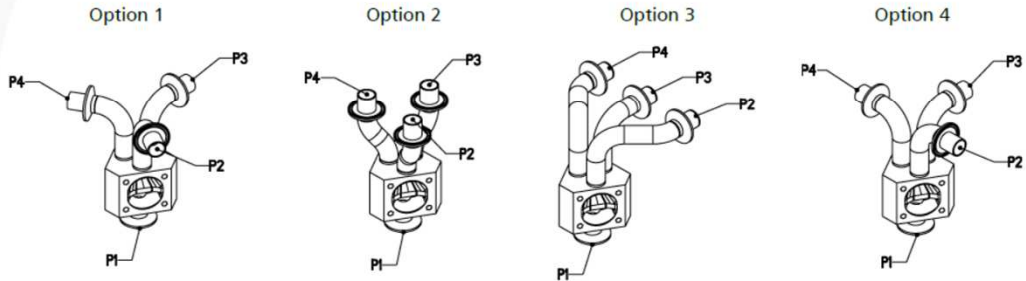

4-Way

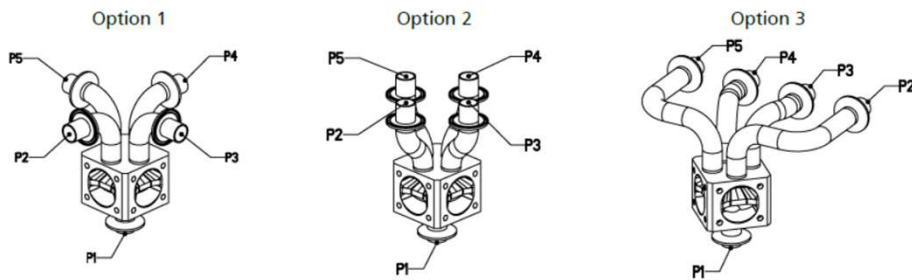

5-Way

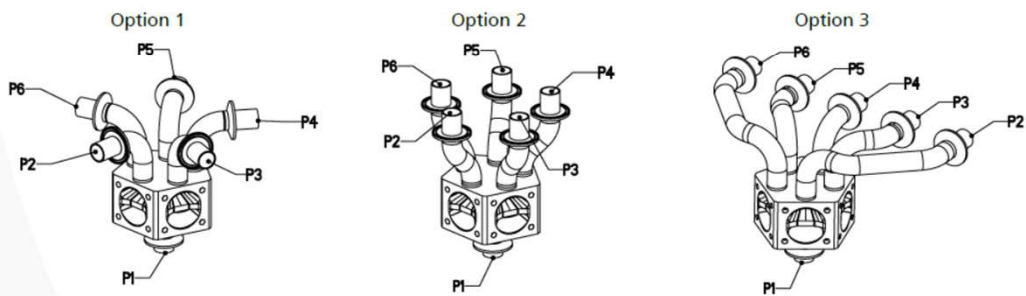

6-Way

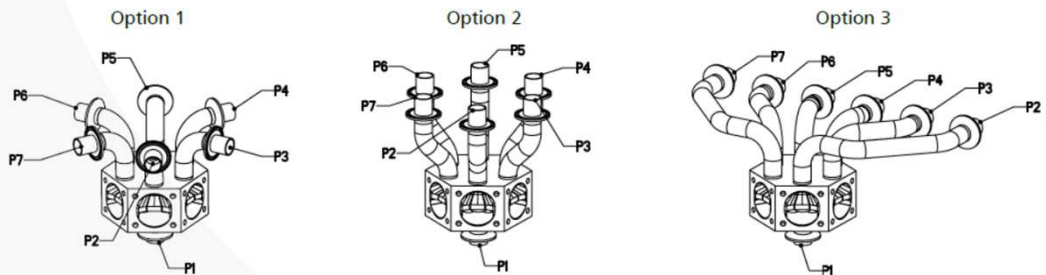

**VALVULAS Y PROCESOS 2007, S.L.**

Orfeo Català, nr. 9

Pol. Ind. Sud

08440 - CARDEDEU

SPAIN

TEL:

00 34 93 755 20 56

FAX:

00 34 93 755 17 75

e-mail:

[jpicallo@vypl.es](mailto:jpicallo@vypl.es)

VAT:

ESB64719958



## Divert & Sterile Access Valves

### Chromatography Valve (CHRO & CHN)

In a typical chromatography process, there is an assembly of five diaphragm valves that connect the chromatography column to the process piping. Manipulating those valves allows the process to flow through the chromatography column in the forward and reverse direction, as well as bypass the column completely. The Pure-Flo Integral Chromatography Valve Assembly accomplishes this task by integrating the required valves while retaining flexibility, minimizing dead legs in the process piping, and reducing the overall space needed for the assembly. The Integral Chromatography Valve provides the process needs of three (3) P&IDs, utilizing four or five valves in one integrally machined assembly, dramatically reducing contact surfaces and hold up volume.

Typical Applications:

- Chromatography



Patent # 6,112,767 and 5,906,223

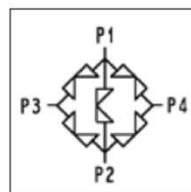

CHRO

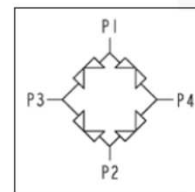

CHN

Integrated  
Block Valves

Flow Path

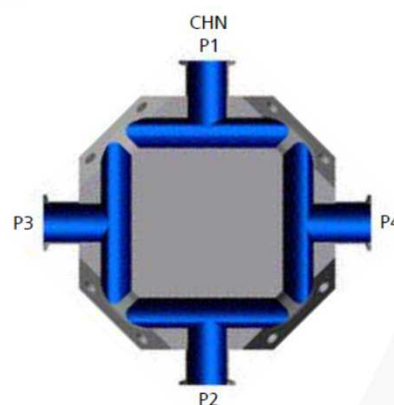
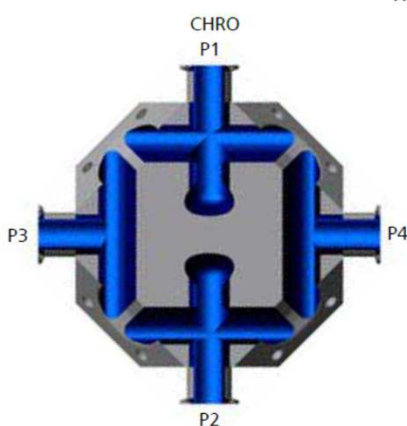

### VALVULAS Y PROCESOS 2007, S.L.

Orfeo Català, nr. 9

Pol. Ind. Sud

08440 - CARDEDEU

SPAIN

TEL:

00 34 93 755 20 56

FAX:

00 34 93 755 17 75

e-mail:

[jpicallo@vyvpsl.es](mailto:jpicallo@vyvpsl.es)

VAT:

ESB64719958

# Divert & Sterile Access Valves

## Crossover (CROD & CRO)

Bioprocessing often requires the use of flow through equipment that must be isolated for maintenance. To facilitate maintenance without shutting down the entire process a configuration of three valves is typically used to isolate and bypass when necessary. The crossover valve integrates these three valves into a single drainable block with minimized deadlegs and hold up volume.

### Typical Applications:

- Isolation and bypass of equipment such as filters, housings and bubble traps.

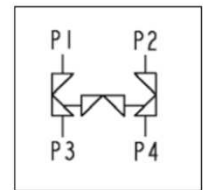
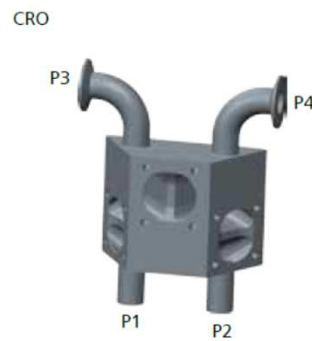
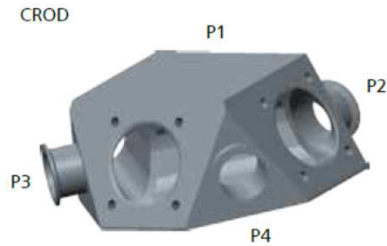

Integrated Block Valves

## Integral Dual Sterile Access (IDSA)

Sterile Access valves are widely used in the Biopharmaceutical industry. Sterile Access valves allow access to the process system for sterilizing, sampling, cleaning, diverting or draining. The Integral Dual Sterile Access valve integrates access on either side of the valve, with minimal deadlegs and hold up volumes. The integrated block design provides the possibility to orient the sterile access valves up or down, which can not be easily accommodated in a sterile access fabrication.

### Typical Applications:

- Cleaning/Sterilization both upstream and downstream of the control point.

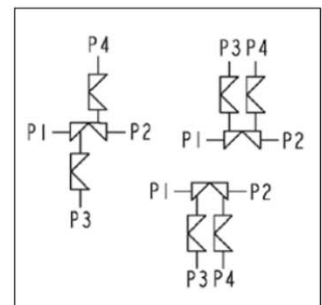

Flow Path

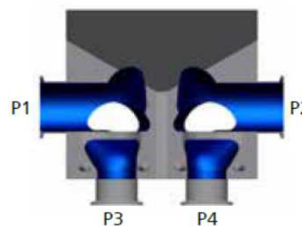

## VALVULAS Y PROCESOS 2007, S.L.

Orfeo Català, nr. 9  
Pol. Ind. Sud  
08440 - CARDEDEU  
S P A I N

TEL: 00 34 93 755 20 56  
FAX: 00 34 93 755 17 75  
e-mail: [jpicallo@vypl.es](mailto:jpicallo@vypl.es)  
VAT: ESB64719958

## Divert & Sterile Access Valves

### Horizontal Divert Valve 3-Way (HDV3W)

3-Way Divert valves are instrumental in achieving efficient, cost effective piping design. Divert valves allow process fluids to be diverted, mixed and/or sampled. Divert valves minimize contact surfaces, minimize hold up volume, reduce CIP cycle times, improve product purity, minimize piping dimensional envelope, and reduce number of system weldments. The Horizontal 3-way divert is specifically designed to be drainable in horizontal installations. The HDV3W is ideal for limited vertical space applications such as under process vessels.

Typical Applications:

- Divert process flow, mixing flow paths, drain and isolation
- Low vertical space installations

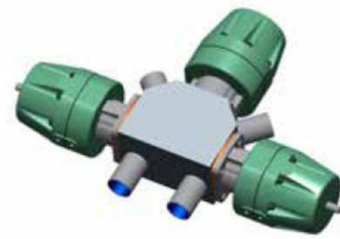

Flow Path

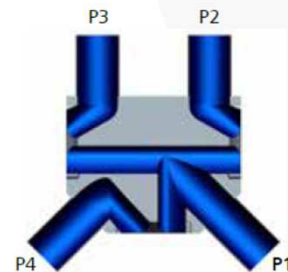
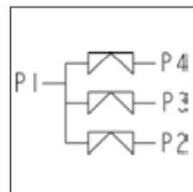

Integrated Block Valves

### Integral Horizontal Sterile Access (IHSA)

The Integral Horizontal Sterile Access (IHSA) is designed for sterile access applications where the piping for the main valve and purge valve are both on a horizontal plane. The IHSA provides additional benefits over standard Horizontal Sterile Access (HSA) fabrications. The IHSA should be used whenever optimal drainability and minimal deadlegs are required in horizontal orientations.

Typical Applications:

- Integral block incorporating second horizontal valve
- Ideal for vertical space constraints

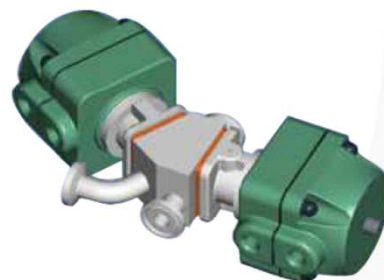

Flow Path

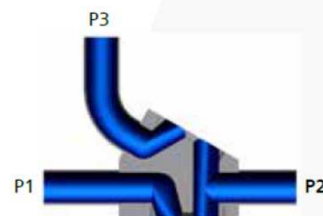
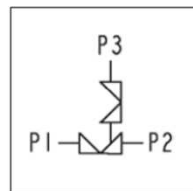

**VALVULAS Y PROCESOS 2007, S.L.**

Orfeo Català, nr. 9  
Pol. Ind. Sud  
08440 - CARDEDEU  
SPAIN

TEL: 00 34 93 755 20 56  
FAX: 00 34 93 755 17 75  
e-mail: [jpicallo@vypl.es](mailto:jpicallo@vypl.es)  
VAT: ESB64719958



## Vessel Valves

### Tank Bottom Valve (TBV)

The Tank Bottom Diaphragm Valve is designed for use at the bottom of a tank or vessel to drain or sample while minimizing the interior sump and preventing any dead leg for bacteria or microorganism entrapment.

Typical Applications:

- Creating an aseptic barrier around bioreactors



Patent # 5,227,401

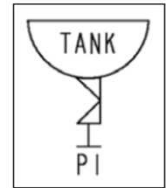

Integrated  
Block Valves

### Sterile Tank Vent Filter Shunt (DV2WS)

The DV2WS is a 2-Way Divert valve designed to facilitate changing from one vent filter to another on WFI storage tanks without interrupting operations.

Normally vent filter cartridges are not changed during operation due to potential for contamination. Large systems designed for continuous use often require two separate vent filtration units. The Sterile Filter Shunt valve is a sterilizable tank vent shunt valve assembly mounted on a single nozzle designed for this purpose.

The steam traced version of this valve when used with a steam jacketed filter housing, will prevent condensation from forming inside the filter housing. The assembly consists of a 2-way divert valve. The upstream side of the valve is connected to the two filter housings. The common port is connected to the tank vent nozzle. A steam condensate discharge port is positioned tangential to the weir of both valves. Two additional valves are used to close the condensate port after sterilization. These valves in turn are connected to a steam trap which then goes to drain.

Typical Applications:

- Used to change a vent filter cartridge on a WFI tank while the system is in operation

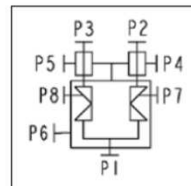

Flow Path

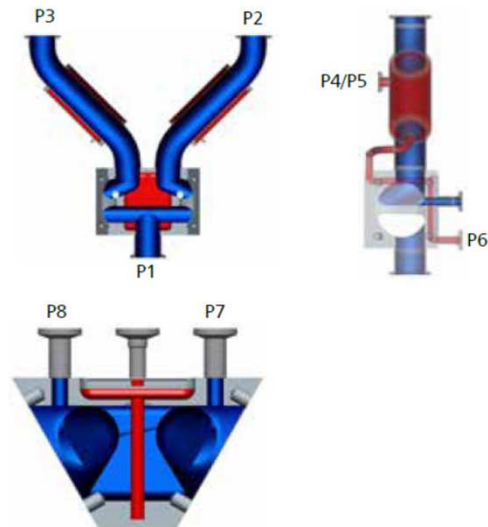

### VALVULAS Y PROCESOS 2007, S.L.

Orfeo Català, nr. 9  
Pol. Ind. Sud  
08440 - CARDEDEU  
SPAIN

TEL: 00 34 93 755 20 56  
FAX: 00 34 93 755 17 75  
e-mail: [jpicallo@vypsl.es](mailto:jpicallo@vypsl.es)  
VAT: ESB64719958

## Vessel Valves

### Block and Bleed (BBD, BBV)

The double block and bleed method of creating an aseptic barrier between two processes is widely utilized in the Bioprocessing industry. Traditionally three standard valves would be fabricated into the double block and bleed configuration. The Block and Bleed Drain (BBD) and Block and Bleed Vent (BBV) valves integrate these three valves into one compact block, minimizing hold up volumes and enhancing cleanability. The compact design allows for greater valve density and flexible system design.

#### Typical Applications:

- Create steam block, isolate and clean chamber for aseptic barrier
- Block line flow for the purpose of draining the line or filling from an auxiliary source

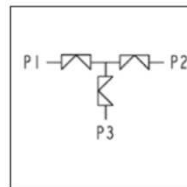

Block & Bleed  
Code: BBD

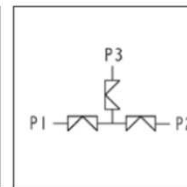

Block & Bleed  
Code: BBV

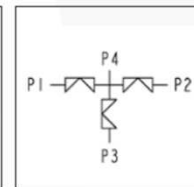

Block & Bleed with  
Optional Vent Port  
Code: BBD-VP

Integrated  
Block Valves

#### Flow Path

##### BBD

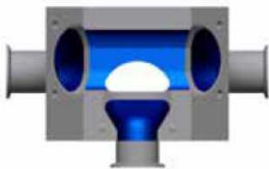

##### BBV

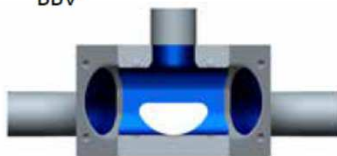

### Bypass or Dual Flow (BYP, DF)

Typical Bioprocessing and Pharmaceutical processes utilize large quantities of water. Processes such as WFI storage, Media hold and Buffer preparation utilize large vessels for holding or preparing the process fluids. The Bypass valve is specifically designed to optimize the fill rate of these large vessels. By utilizing two different flow paths the process can be filled quickly with the larger valve and filled at a slower rate by the smaller valve for topping off the process, saving significant time in the process.

#### Typical Applications:

- Tank filling applications



#### Flow Path

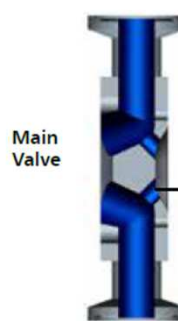

Main Valve

Bypass

I.D. .18in  
(4.5mm)

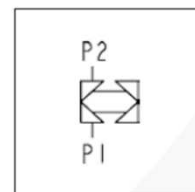

Bypass  
Code: BYP



Main Valve

Bypass

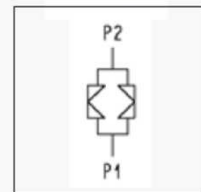

Dual Flow  
Code: DF

### VALVULAS Y PROCESOS 2007, S.L.

Orfeó Català, nr. 9  
Pol. Ind. Sud  
08440 - CARDEDEU  
SPAIN

TEL: 00 34 93 755 20 56  
FAX: 00 34 93 755 17 75  
e-mail: [jpicallo@vypl.com](mailto:jpicallo@vypl.com)  
VAT: ESB64719958



# Vessel Valves

## Integral Sterile Barrier (SB1)

The Sterile Barrier block addresses the issues of achieving sterile barrier technology and utilizing a small dimensional envelope while minimizing contact surfaces and hold up volume. The Integral Sterile Barrier consists of four valves machined from a single block. The common chamber is located in the center of the block and the independent ports are located on the ends. The assemblies consist of two product valves, a steam injection valve and a condensate drain valve. When the two product valves are open and the steam injection and condensate valves are closed, product flows through to the reactor. When the product valves are closed, a chamber is formed between the two valves which, when injected with steam, provides a sterile barrier isolating the reactor.

### Typical Applications:

- Creating an aseptic barrier around bioreactors

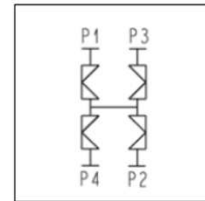

Integrated Block Valves

Flow Path

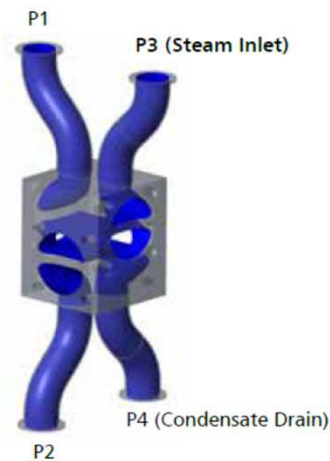
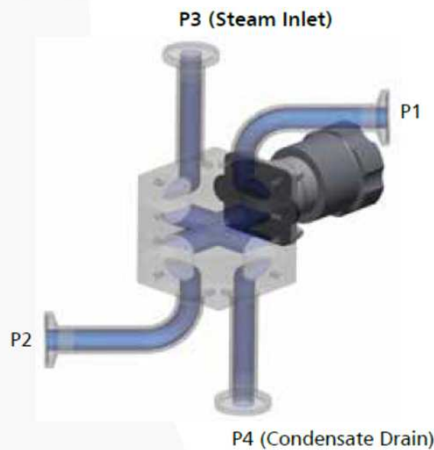

## VALVULAS Y PROCESOS 2007, S.L.

Orfeó Català, nr. 9

Pol. Ind. Sud

08440 - CARDEDEU

SPAIN

TEL: 00 34 93 755 20 56

FAX: 00 34 93 755 17 75

e-mail: [jpicallo@vypl.es](mailto:jpicallo@vypl.es)

VAT: ESB64719958

# P&ID Cross Reference

## Zero Static Use Points

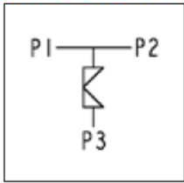

Zero Static Block Body  
Code: ZSBT

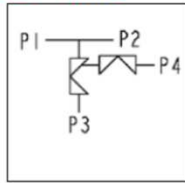

Zero Static Back to Back Sample  
Code: ZSBBS

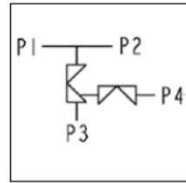

Zero Static with Downstream Purge  
Code: ZDPT, ZDPB

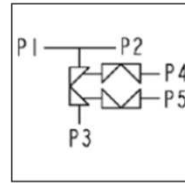

Zero Static with Upstream Sample and Downstream Purge  
Code: ZUD

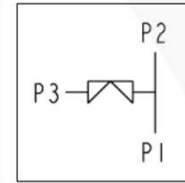

Zero Static Block Body with Vertical Run  
Code: ZSBV

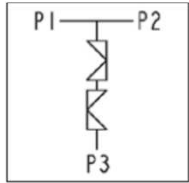

Zero Static Dual Inline  
Code: ZDI

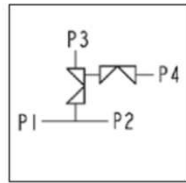

Zero Static Inverted with Drain (ZID)

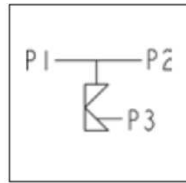

Zero Static Block Body with Back Outlet Option (ZSBT-BO)

## Divert and Sterile Access Valves

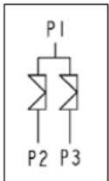

2-Way Divert Valve  
Code: DV2W

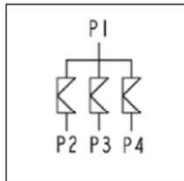

3-Way Divert Valve  
Code: DV3W

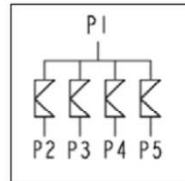

4-Way Divert Valve  
Code: DV4W

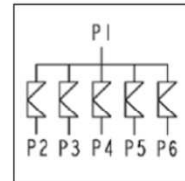

5-Way Divert Valve  
Code: DV5W

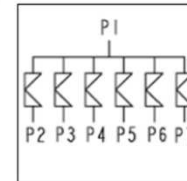

6-Way Divert Valve  
Code: DV6W

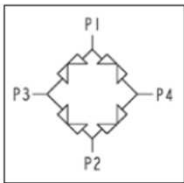

Chromatography without Bypass  
Code: CHN

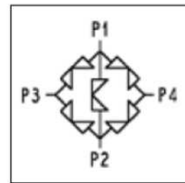

Chromatography with Bypass  
Code: CHRO

## VALVULAS Y PROCESOS 2007, S.L.

Orfeó Català, nr. 9

Pol. Ind. Sud

08440 - CARDEDEU

SPAIN

TEL: 00 34 93 755 20 56

FAX: 00 34 93 755 17 75

e-mail: [jpicallo@vypl.es](mailto:jpicallo@vypl.es)

VAT: ESB64719958

# P&ID Cross Reference

## Divert and Sterile Access Valves (cont.)

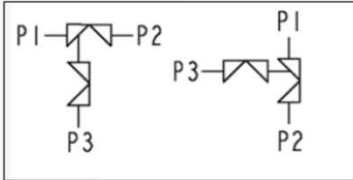

Integral Sterile Access and GMP  
Code: ISG

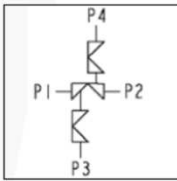

Integrated Dual Sterile Access  
Code: IDSA

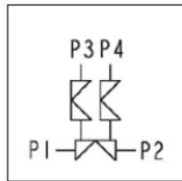

Integrated Dual Sterile Access  
Code: IDSA

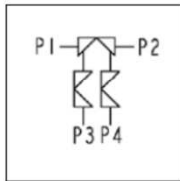

Integrated Dual Sterile Access  
Code: IDSA

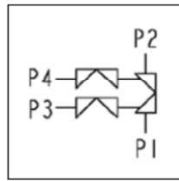

Integrated Dual Sterile Access  
Code: IDSA

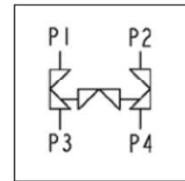

Crossover  
Code: CRO/CROD

## Vessel Valves



Tank Bottom Valve  
Code: TBV

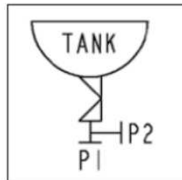

Tank Bottom Valve with CIP/SIP Port  
Code: TBV

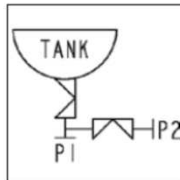

Tank Bottom Valve with CIP/SIP Valve  
Code: TBV

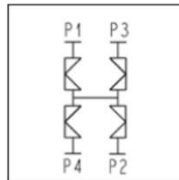

Sterile Barrier  
Code: SB1

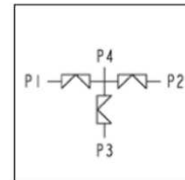

Block & Bleed with Vent Port  
Code: BBD-VP

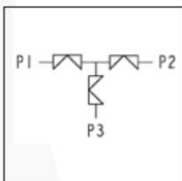

Block & Bleed  
Code: BBD

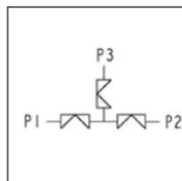

Block & Bleed  
Code: BBV

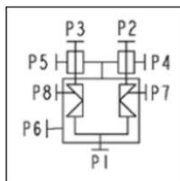

Sterile Filter Shunt Valve  
Code: DV2WS

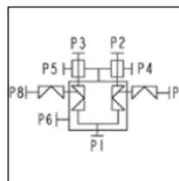

Sterile Filter Shunt Valve with Condensate Drain Valves  
Code: DV2WS

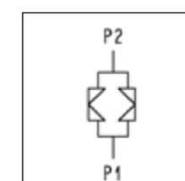

Dual Flow  
Code: DF

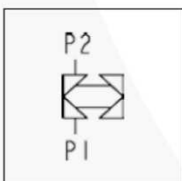

Bypass  
Code: BYP

## VALVULAS Y PROCESOS 2007, S.L.

Orfeó Català, nr. 9

Pol. Ind. Sud

08440 - CARDEDEU

SPAIN

TEL: 00 34 93 755 20 56

FAX: 00 34 93 755 17 75

e-mail: [jpicallo@vypl.es](mailto:jpicallo@vypl.es)

VAT: ESB64719958